

**Data Hub**  
**User manual**

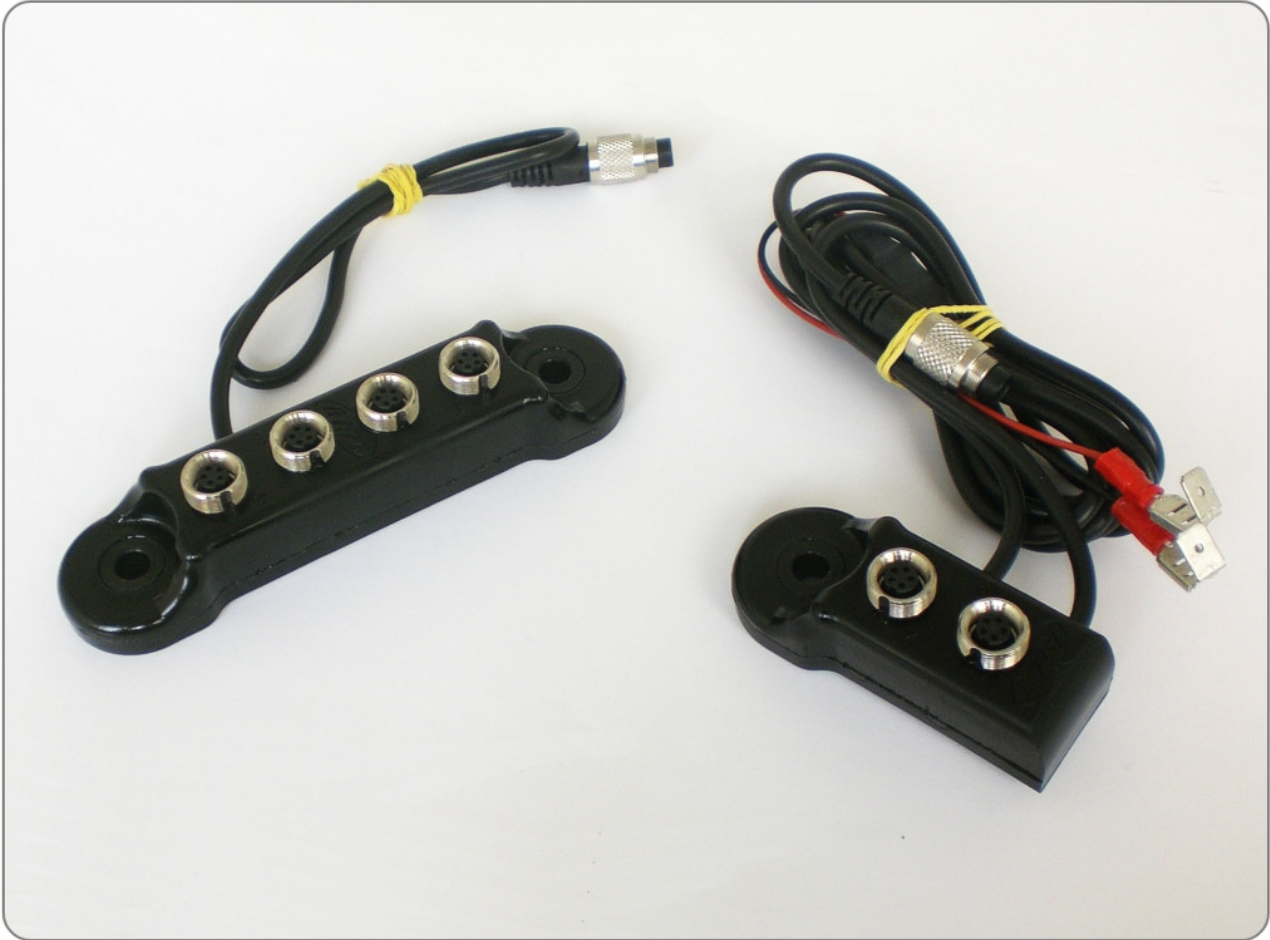

**Racing Data Power**

## Index

Chapter 1 – Data Hub: part numbers, optional and installation .....	4
1.1 – Part numbers .....	4
1.2 – Optional.....	4
1.3 – How to install Data Hub .....	4
Chapter 2 – How to use Data Hub .....	5
2.1 – Two ways Data Hub.....	5
2.2 – Four ways Data Hub.....	6
Appendix – Technical drawings .....	8

## Introduction

**Data Hub** is the new CAN connections multiplier to interface AIM data loggers (**MXL Pro/Pista**, **EVO3 Pro/Pista**, **EVO4**, **MyChron4**) with its peripherals using one only cable and minimizing wiring overall.

**Data Hub** is available in two versions.

**Two ways Data Hub** with external power.

**Four ways Data Hub** to allow the CAN connection of more peripherals.

It is also possible to connect more **Data Hub** in sequence to increase the number of CAN peripherals connected (see chapter 2 for further information).

**Data Hub** is waterproof IP65.

## Chapter 1 – Data Hub: part numbers, optional and installation

**Data Hub** is available in two versions shown here below: 2 ways and 4 ways.



### 1.1 – Part numbers

**Two ways Data Hub:**

**X08HB2GK0**

**Four ways Data Hub** is available with two different cables:

- 4 ways Data Hub **with 40 cm cable:**
- 4 ways Data Hub **with 150 cm cable:**

**X08HUB010**

**X08HUB150**

### 1.2 – Optional

4 Data Hub external power cable:

**V02557020**

### 1.3 – How to install Data Hub

All **Data Hub** have lateral installation holes: one for two ways and two for four ways. Please pay attention not to install the hub near to heat sources or source of electromagnetic interference.

## Chapter 2 – How to use Data Hub

The two **Data Hub** are recommended for different applications but the main difference between them is the availability in the two ways version of external power with free cables as shown here below.

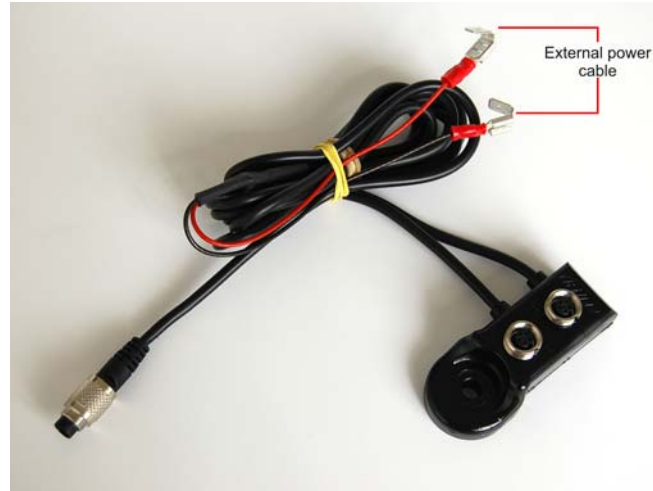

Four ways **Data Hub**, on the contrary, need the proper optional cable for external power to be plugged in one of the 4 inputs.

**Please note: when installing Data Hub to connect an AIM logger to its external expansion modules, both devices must be OFF.**

### 2.1 – Two ways Data Hub

**Two ways Data Hub** is recommended for those installations that need CAN line remotation or in case **SmartyCam**, the AIM on board camera, is connected to logger like **EVO3 Pro** or **MXL Pro05** with old generation cables. In those situations **SmartyCam** is not powered by the logger and needs the external power to be connected to the two ways **Data Hub**. Below connections schemes show the two situation as well as cables part numbers.

To know in which other connections a two ways **Data Hub** is needed refer to [www.smartycam.com](http://www.smartycam.com) connections section.

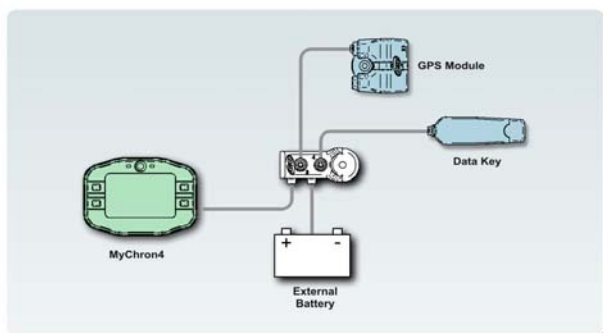

**MyChron4 – GPS Module – Data Key connection with two ways Data Hub.**

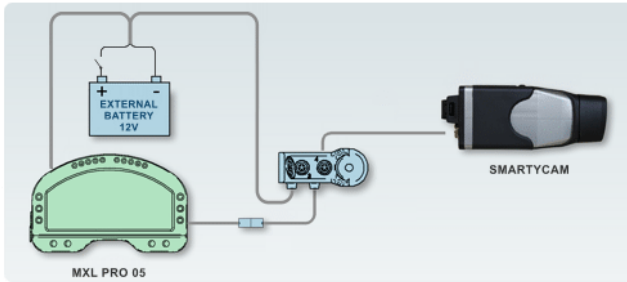

**MXL Pro05** (with wiring V04.554.24) – **SmartyCam** connection with two ways **Data Hub**.

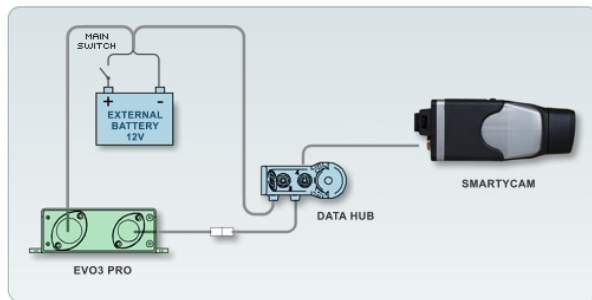

**EVO3 Pro** (with wiring V04.549.53) – **SmartyCam** connection with two ways **Data Hub**.

## 2.2 – Four ways Data Hub

Four ways **Data Hub** is recommended for those installations that need to increase the number of connected peripherals. Below schemes show connection of **EVO3 Pro** and **MXL Pro05** with **SmartyCam** as well as part numbers of the needed cables.

To know in which other connections a four ways **Data Hub** is needed refer to [www.smartycam.com](http://www.smartycam.com) “Connections” section.

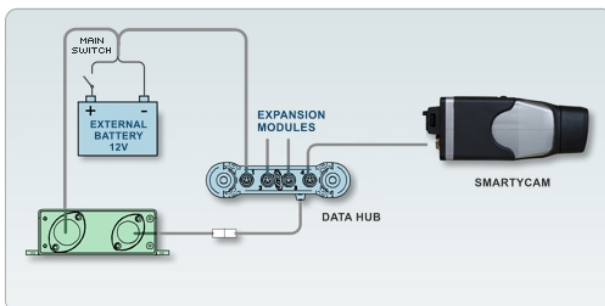

**EVO3 Pro** (with wiring V04.549.53) – **SmartyCam** connection with 4 ways **Data Hub**.

External power cable (V02557020) is to be plugged in one of **Data Hub** four inputs because without an external battery connected to the vehicle master switch AIM logger cannot power **SmartyCam** too.

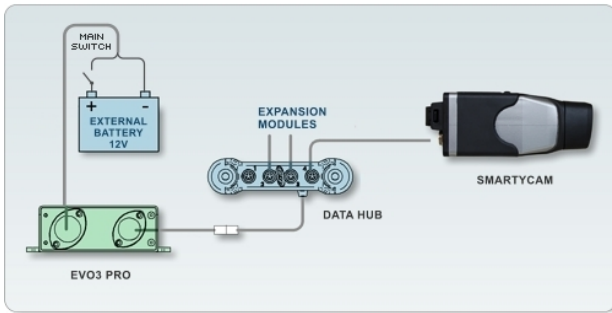

**EVO3 Pro (with wiring V04.549.53/A) – SmartyCam connection with 4 ways Data Hub.**

In the connection scheme here on the left **SmartyCam** is powered through the CAN connection cable.

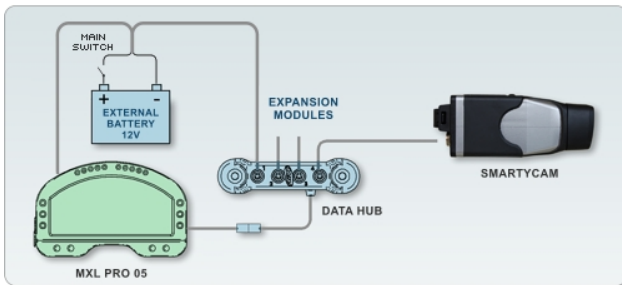

**MXL Pro05 (with wiring V04.554.24) – SmartyCam connection with 4 ways data hub.**

External power cable (V02557020), is to be connected to one of the four **Data Hub** input because without an external battery connected to the vehicle master switch AIM logger cannot power **SmartyCam** too.

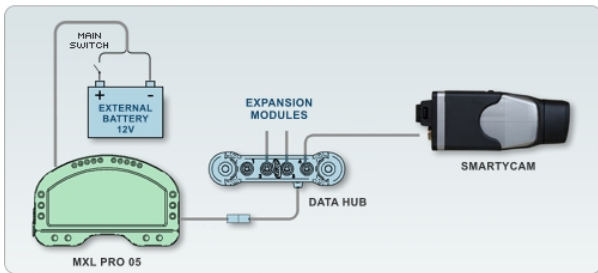

**MXL Pro05 (with wiring V04.554.24/A) – SmartyCam connection.**

In the connection scheme here on the left **SmartyCam** is powered through the CAN cable.

The image here below shows a network with 4 ways **Data Hub** connected in sequence:

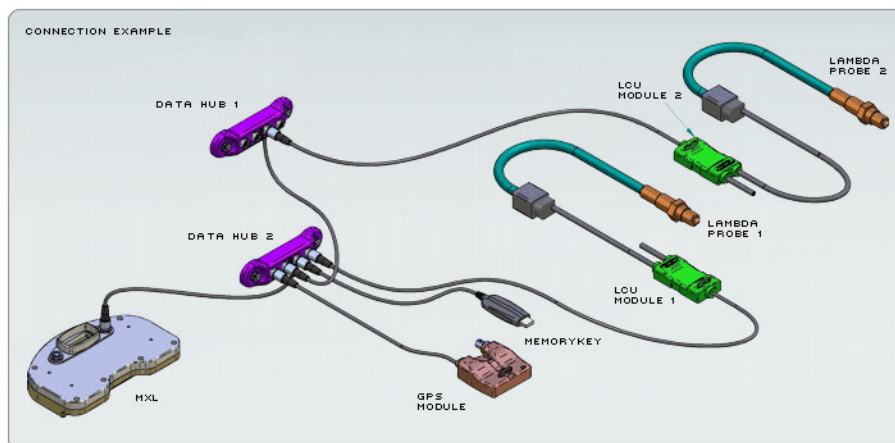

## Appendix – Technical drawings

### Two ways Data Hub pinout

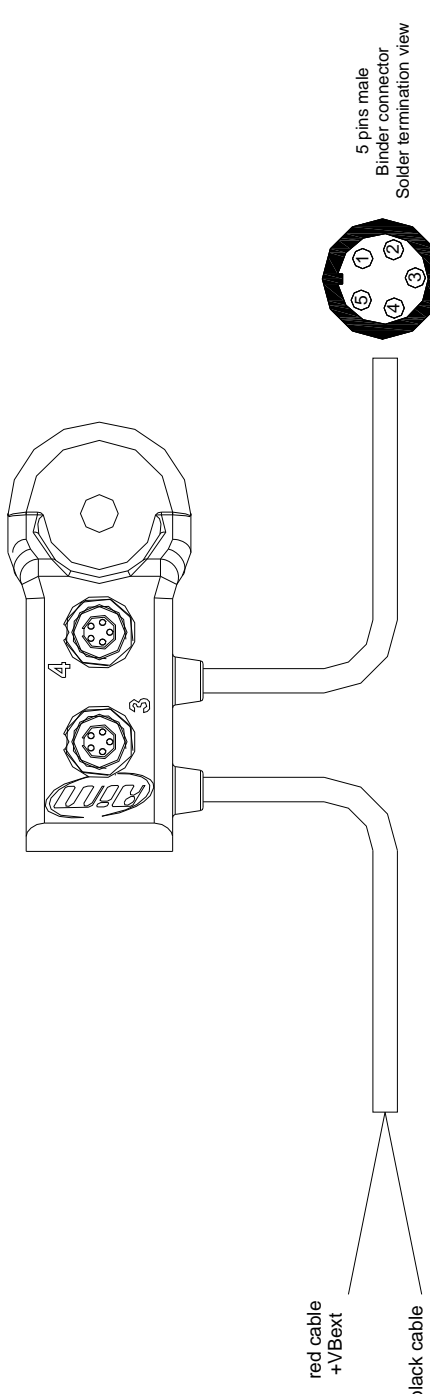

5 pins male Binder connector Solder termination view

red cable +VBext

black cable

5 pins male Binder connector pinout	
1	CAN+
2	GND
3	+Vb
4	CAN-
5	+VBext

  

5 pins female Binder connector pinout Position 4	
1	CAN+
2	GND
3	+Vb
4	CAN-
5	+VBext

  

5 pins female Binder connector pinout Position 3	
1	CAN+
2	GND
3	+Vb
4	CAN-
5	+VBext



  



5 pins Binder female connector Solder termination view

Rif. / Ref.	Q.tà/Q.ty	Material / Material	N. articolo / Item N.		
Progettato da / Designed by	Contr. da / Ckd. by	Approvato da / Approved by	Nome file / File name		Scala / Scale
		Titolo / Title			
		<b>Pinout Data Hub a due vie</b>			Rev. / Rev.

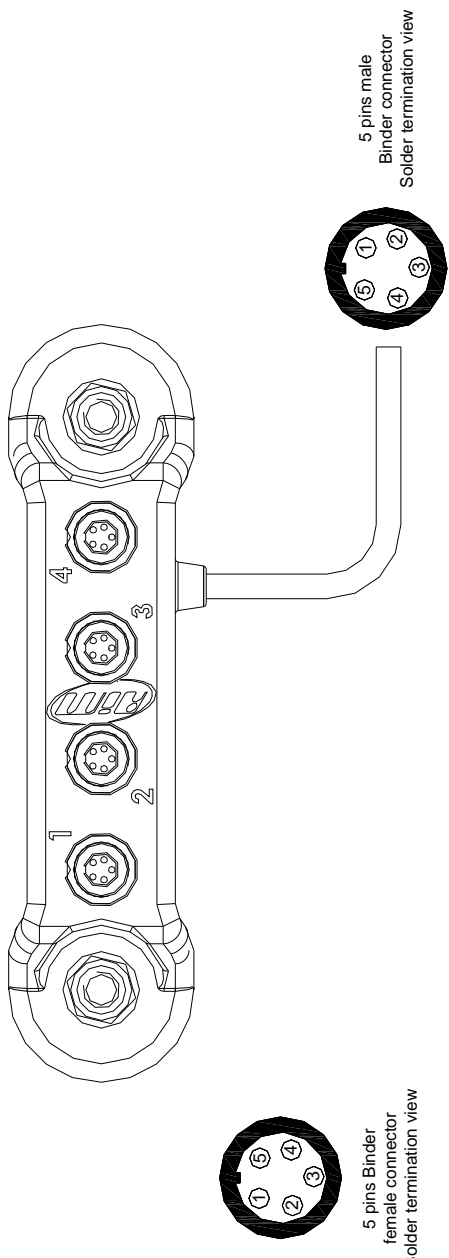

N. rev. / Rev. N.		Descrizione / Description			Data / Date	Firma / Signature	Contr. da / Ckd. by									
<h1>Four ways Data Hub pinout</h1>  <p>5 pins male Binder connector Solder termination view</p> <p>5 pins Binder female connector Solder termination view</p>																
		5 pins female Binder connector pinout Position 1			5 pins female Binder connector pinout Position 2			5 pins female Binder connector pinout Position 3			5 pins female Binder connector pinout Position 4			5 pins male Binder connector pinout		
1	CAN+	1	CAN+	1	CAN+	1	CAN+	1	CAN+	1	CAN+	1	CAN+	1	CAN+	
2	GND	2	GND	2	GND	2	GND	2	GND	2	GND	2	GND	2	GND	
3	+Vb	3	+Vb	3	+Vb	3	+Vb	3	+Vb	3	+Vb	3	+Vb	3	+Vb	
4	CAN-	4	CAN-	4	CAN-	4	CAN-	4	CAN-	4	CAN-	4	CAN-	4	CAN-	
5	+VBext	5	+VBext	5	+VBext	5	+VBext	5	+VBext	5	+VBext	5	+VBext	5	+VBext	
Rif. / Ref.		Q.tà/Q.ty	Material / Material			N. articolo / Item N.										
Progettato da / Designed by		Contr. da / Ckd. by	Approvato da / Approved by		Nome file / File name		Data / Date	Scala / Scale								
			Titolo / Title					Rev. / Rev.		Foglio / Sheet						
			Pinout Data Hub a quattro vie							1 of 1						
			N. disegno / Drawing N.													