

User Manual

AIM ECULog / Data Logger



BA

memotec GmbH
Bauwaldstrasse 1
D-75031 Eppingen

+49.7260.920440
info@me-mo-tec.de

www.me-mo-tec.de

User Manual

ECULog

Release 1.02





INDEX

1 – ECULog in a few words	3
2 – Available kits	3
3 – ECULog expansions and connections	5
4 – Configuration with RaceStudio 3 software	6
4.1 – Channels configuration	7
4.2 – ECU Stream configuration	8
4.3 – CAN Expansions configuration	9
4.4 – Math channels configuration	14
4.5 – Status Variables configuration	15
4.6 – Parameters configuration	18
4.7 – SmartyCam Stream	19
4.8 – CAN Output configuration	20
4.9 – Transmitting the configuration to ECULog	20
5 – Dimensions, pinout and technical characteristics	21

1 – ECULog in a few words

ECULog is a little, light and easy to use logger that samples and records channels coming from the vehicle ECU and from the connected CAN expansions

It records the data both into the internal 4GB not volatile memory and in the USB-C memory card.

ECULog allows the user to create math channels as well as a CAN Output using both the channels supplied by the vehicle ECU and these supplied by AiM CAN Expansions. All channels can also be displayed on SmartyCam videos when available.

AiM supported expansions are:

- GPS09c Pro Module
- GPS09c Pro Open Module
- LCU-One CAN
- LCU1
- Channel Expansion
- ACC
- ACC2
- ACC2 Open

2 – Available kits

ECULog is available in different kits.

ECULog CAN/RS232 kit: part number

X08ECULOGCRS200

- ECULog (1)
- 2m CAN/RS232+External power cable (2)
- 2m USB 2.0 Type A – Type C cable (3)
- 16GB Mini USB Drive (4)





ECULog OBDII kit: part number

X08ECULOGOBD200

- ECULog (1)
- 2m CAN/OBDII +power cable (2)
- 2m USB 2.0 Type A-Type C cable (3)
- 16GB Mini USB Drive (2)



Accessories and spare parts:

- 2m CAN/RS232 +power cable
- 2m CAN/OBDII/K-Line + power cable
- 2m USB 2.0 Type A-Type C cable
- 16GB mini USB Drive

V02.589.050
V02.589.040
X90TMPC101010
3IRUSBD16GB

Please note: for connecting ECULog to the PC use the **2m USB2.0 Type A-Type C cable** whose part number is **X90TMPC101010** you find in the kit. Any connection using an USB C – USB C cable may not work properly.

3 – ECULog expansions and connections

ECULog supports the following AiM expansions:

- GPS09c Pro
- GPS09c Pro Open Module
- LCU One CAN
- LCU1
- Channel Expansion
- ACC
- ACC2
- ACC2 Open

The image below shows an example of AiM CAN Network.

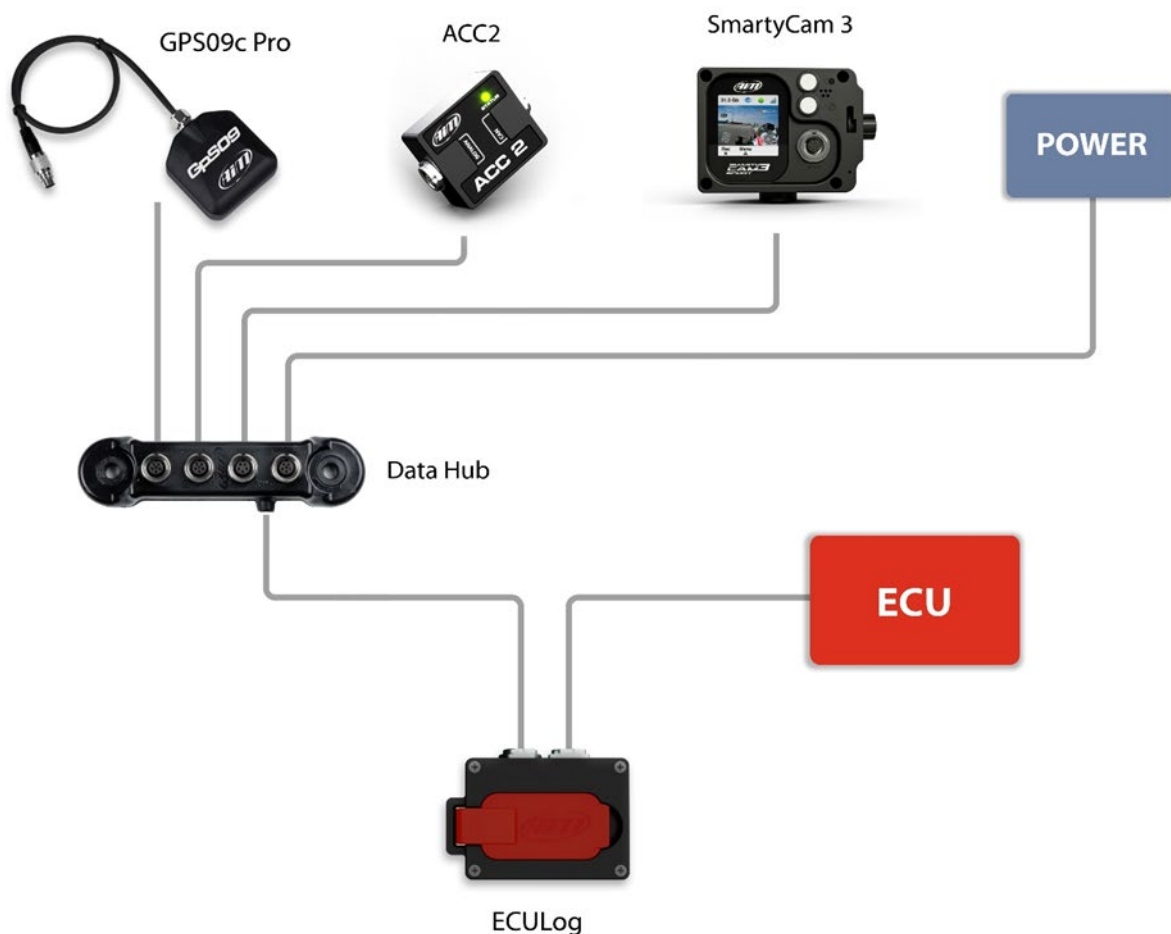

4 – Configuration with RaceStudio 3 software

To configure ECULog follow these steps:

- run RaceStudio 3
- press “New” button on the top right keyboard (1)
- select ECULog (2)
- press “OK” (3)
- name the configuration if desired (default name is ECULog – 4)
- press “OK” (5).

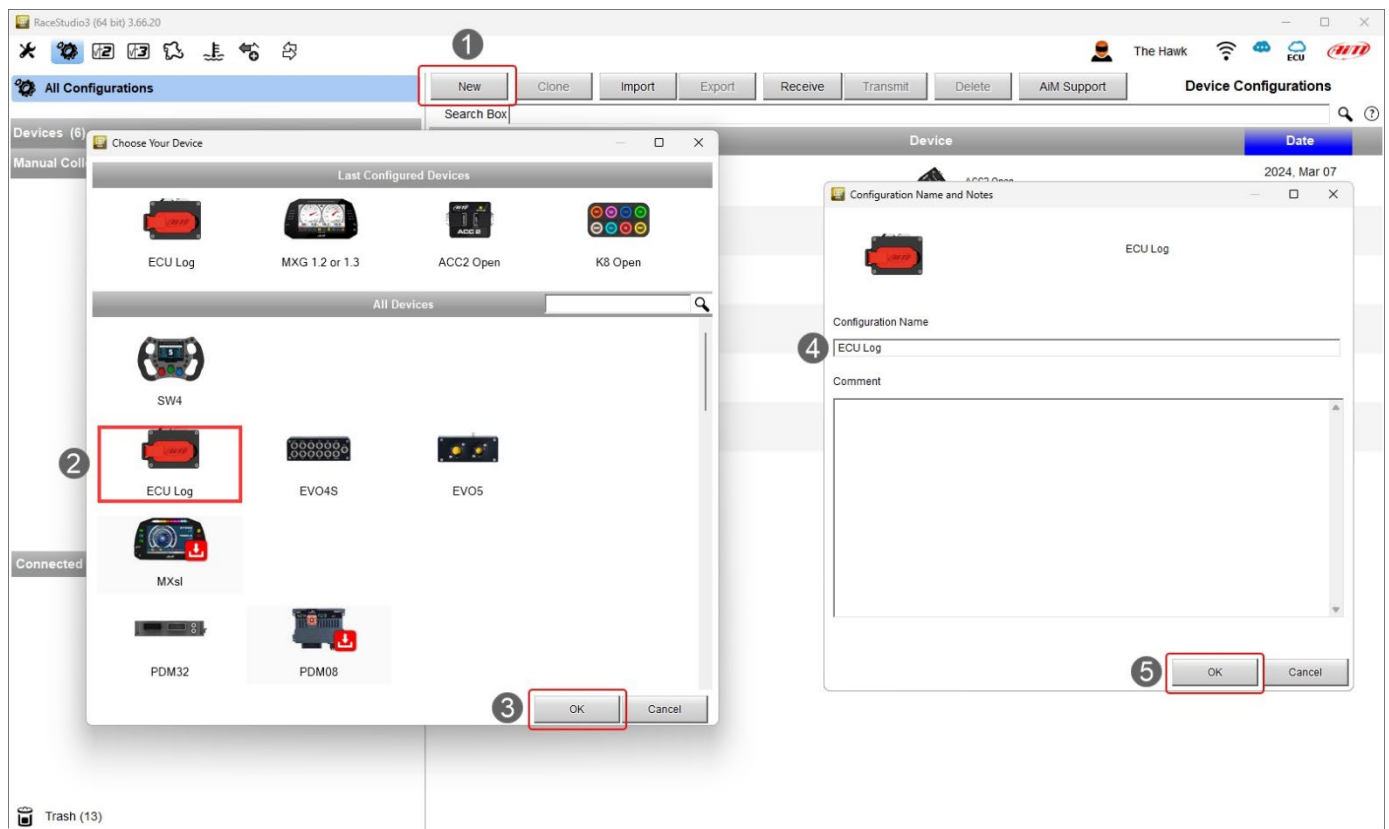

Once the configuration created it is necessary to configure, when possible, the following tabs:

- Channels
- ECU Stream
- CAN Expansions
- Math Channels
- Status Variables
- Parameters
- SmartyCam Stream
- CAN Output

4.1 – Channels configuration

- Once the configuration created, the software enters “Channels” tab.

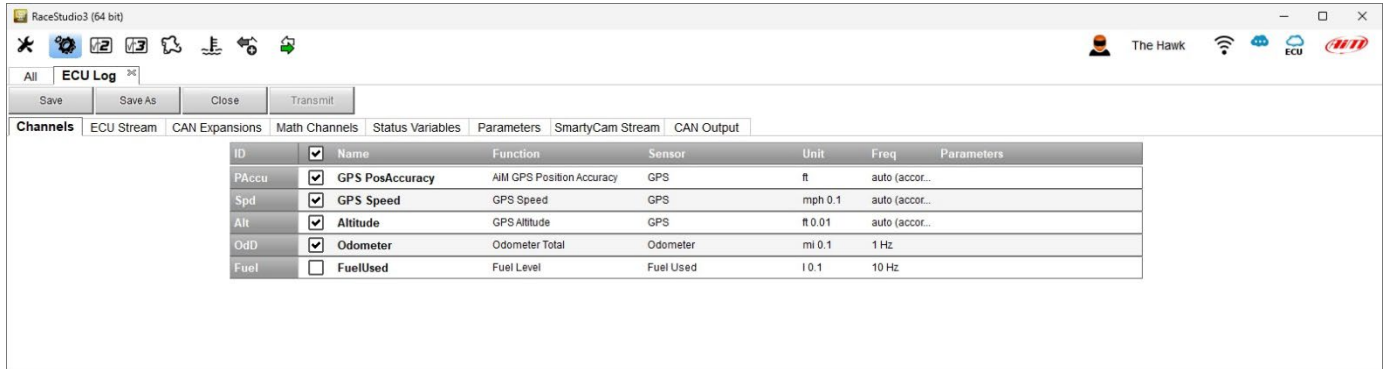

It shows GPS channels, as well as odometer and it is possible to specify the fuel level. For these information to be available it is mandatory:

- to connect an optional GPS09c Pro/09c Pro Open Module using a DataHub, as shown in chapter 3
- to have an ECU that supplies fuel level information or to connect and configure a custom sensor.

Setting an ECU that supplies fuel level information in “ECU Stream” tab (paragraph 4.2) the software informs the user.

4.2 – ECU Stream configuration

Entering “ECU Stream” tab a panel where to choose the connected ECU is prompted.

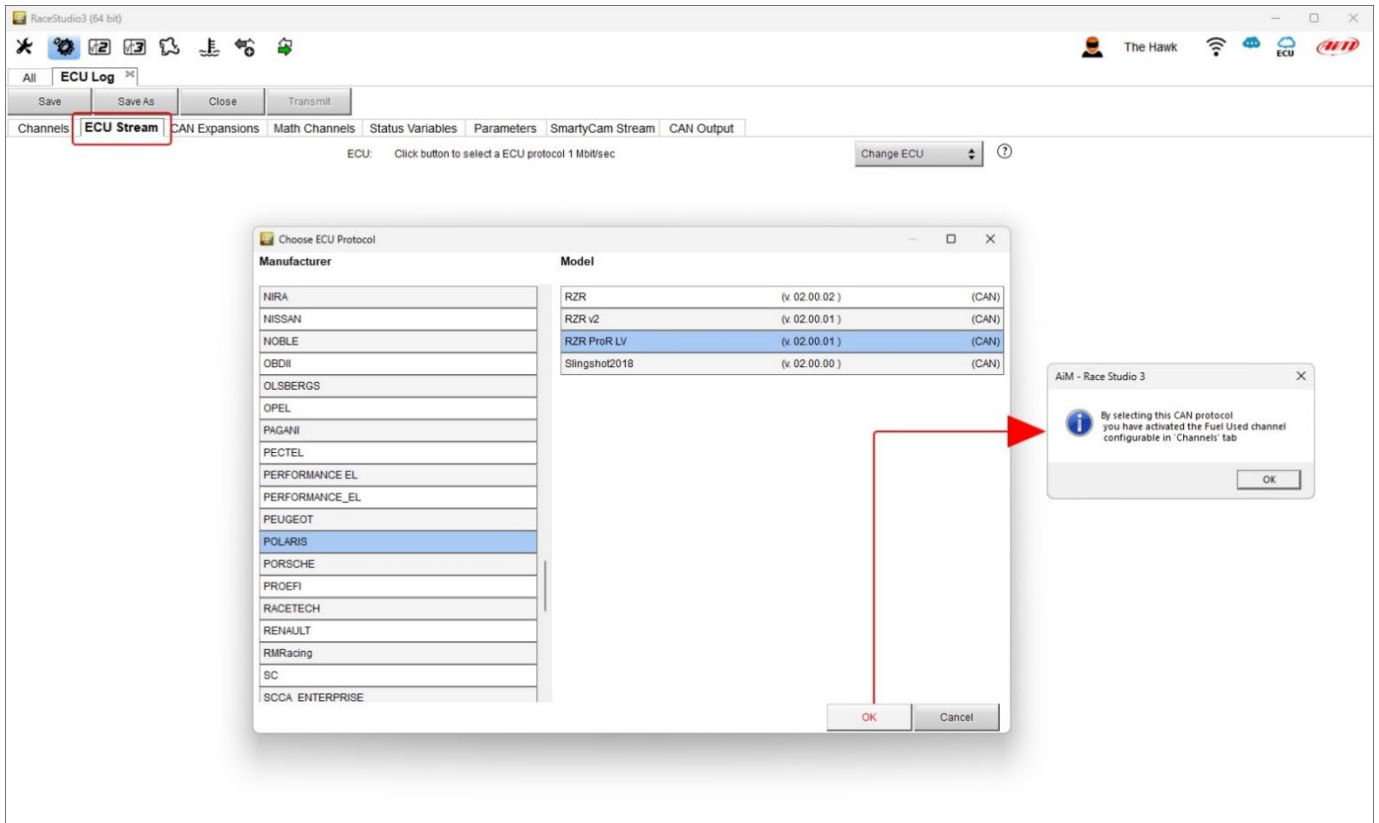

Selecting an ECU that supplies information about fuel level the software informs the user as shown above and the corresponding channel is enabled in “Channels” Tab.

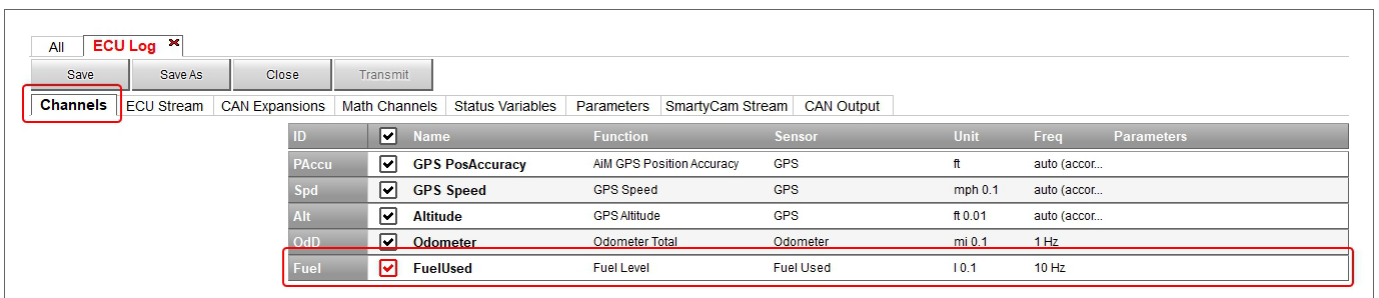

4.3 – CAN Expansions configuration

Entering “CAN Expansions” tab a selection panel is prompted.

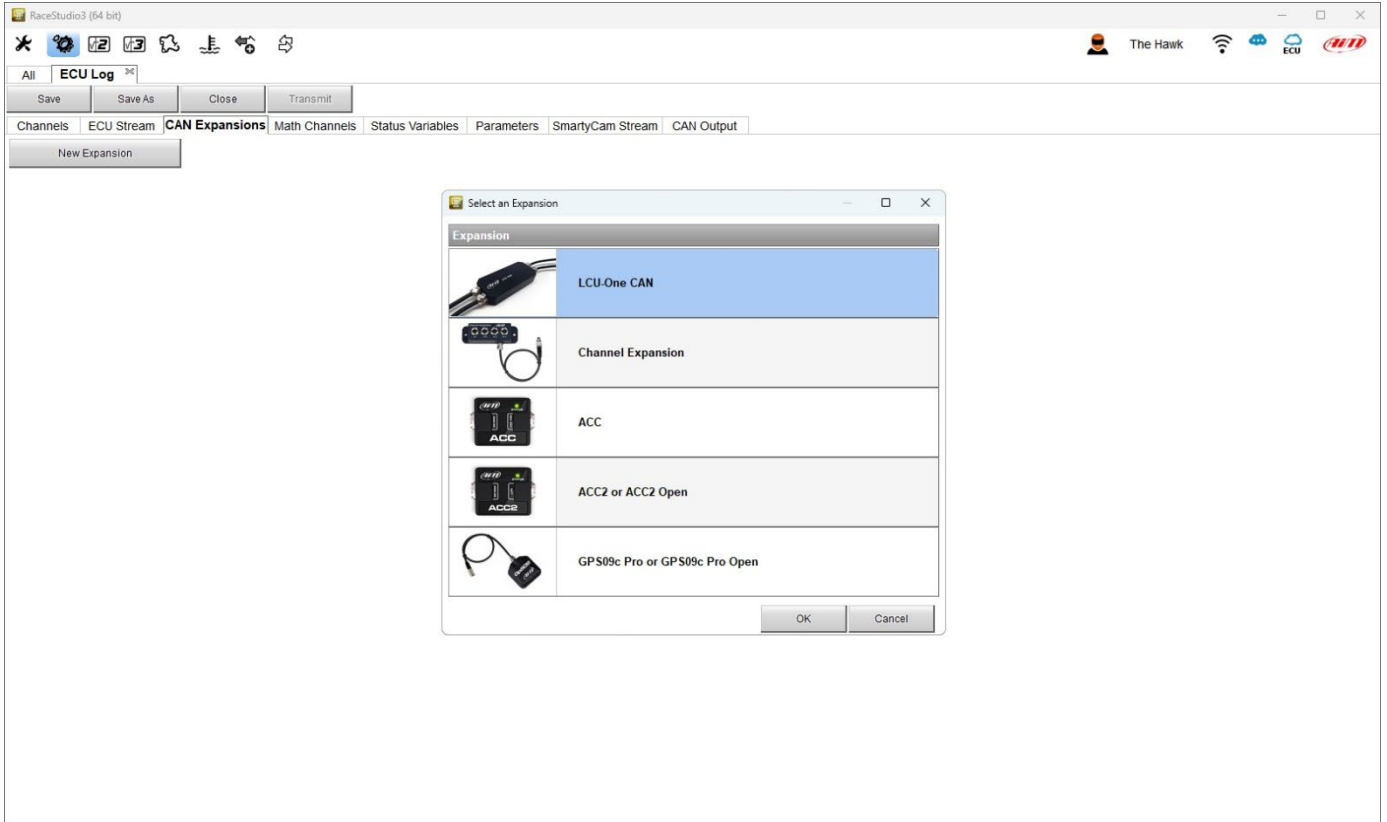



Each expansion needs to be configured through the dedicated panel. In the following pages they are shown. Please refer to the single user manuals for further information.

LCU One CAN setting panel. It is possible to select the multiplier to calculate AFR from lambda and add a custom value.

The screenshot shows the RaceStudio3 (64 bit) interface. The 'CAN Expansions' tab is active, displaying the 'New Expansion' panel for 'LCC'. The 'Expansion Name' is 'LCC' and the 'Expansion Serial Number' is '0'. A dropdown menu for 'Multiplier to calculate AFR (A/F) from lambda' is open, showing options: 6.40 - Methanol, 9.00 - Ethanol, 14.57 - Gasoline (highlighted), 14.60 - Diesel, 15.50 - LPG (Propane), and 17.20 - CNG. A red arrow points from the 'Add Custom Value' button to the 'Lambda Multiplier Manager' dialog box. The dialog box has a table with the following data:

Multiplier Lambda Values	New Value	Label for New Value
6.40 - Methanol	14.57	Gasoline
9.00 - Ethanol		
14.57 - Gasoline		
14.60 - Diesel		
15.50 - LPG (Propane)		
17.20 - CNG		

Below the multiplier list is a table of parameters:

ID	Name	Function	Sensor	Unit	Freq
Lmd	Lambda	Inner Lambda	LCU-One Lambda	lambda 0.01	10 Hz
AFR	AFR	Inner AFR	LCU-One AFR	AF 0.01	10 Hz
LTm	LmdTmp	Inner Lambda Temperature	LCU-One Temp	F 0.1	10 Hz
LDg	Diagn	Inner Lambda Diagnosis	LCU-One Diagn	#	1 Hz

The 'Lambda Multiplier Manager' dialog box also includes buttons for 'Add or Modify Current Item', 'Remove Current Item', and 'Restore Default Values', along with 'OK' and 'Cancel' buttons.



Channel Expansion and **ACC, ACC2** (all versions) are mutually exclusive; this is why setting one of them the others will not be available in CAN Expansions list.

Channel Expansion channels can be set as digital or as analog.

The screenshot shows the RaceStudio3 interface with the 'CAN Expansions' tab selected. A table lists four channels (C01-C04) with their respective settings. Two 'Channel Settings' dialog boxes are open, showing the configuration for 'Channel01'. The top dialog shows 'Analog' selected, and the bottom dialog shows 'Digital' selected. A red box highlights the 'Analog' and 'Digital' radio buttons in both dialogs, with a red line connecting them to the corresponding rows in the table.

ID	Name	Function	Sensor	Unit	Freq
C01	Channel01	Voltage	Generic 0-5 V	mV	20 Hz
C02	Channel02	Voltage	Generic 0-5 V	mV	20 Hz
C03	Channel03	Voltage	Generic 0-5 V	mV	20 Hz
C04	Channel04	Voltage	Generic 0-5 V	mV	20 Hz

Channel Settings (Analog)

- Name: Channel01
- Name for display: C01
- Function: Voltage
- Sensor: Generic 0-5 V
- Sampling Frequency: 20 Hz
- Unit of Measure: mV

Channel Settings (Digital)

- Name: Channel01
- Name for display: C01
- Function: Vehicle Speed
- Sensor: Speed Sensor
- Sampling Frequency: 20 Hz
- Unit of Measure: mph
- Display Precision: no decimal place
- Logged:
- Speed Parameters:
 - Wheel circumference [in]: 65
 - Pulse per wheel revolution: 1



ACC, ACC2 (all versions) and **Channel Expansion** are mutually exclusive; this is why setting one of them the others will not be available in available CAN Expansions list.

ACC setting panel. Clicking on each channel a configuration panel is prompted.

The screenshot shows the RaceStudio3 interface with the 'CAN Expansions' tab selected. A 'New Expansion' dialog is open, showing 'ACC' as the selected expansion. Below this, a table lists four channels (Ch01 to Ch04) with their respective settings. A red box highlights this table. To the right, a 'Channel Settings' dialog is open for 'ACC Channel01', showing configuration options for Name, Name for display, Function, Sensor, Sampling Frequency, and Unit of Measure.

ID	✓	Name	Function	Sensor	Unit	Freq
Ch01	✓	ACC Channel01	Voltage	Generic 0-5 V	mV	20 Hz
Ch02	✓	ACC Channel02	Voltage	Generic 0-5 V	mV	20 Hz
Ch03	✓	ACC Channel03	Voltage	Generic 0-5 V	mV	20 Hz
Ch04	✓	ACC Channel04	Voltage	Generic 0-5 V	mV	20 Hz



ACC2 and **ACC2 Open** can support up to four thermocouple. Selecting the number of thermocouple sensors it is supposed to connect the corresponding channels in the table bottom of the view switches to temperature channel; the remaining channels are configurable using the configuration panel that is prompted clicking the corresponding channel row in the table.

Please note: ACC2 Open as an expansion works exactly as ACC2.

Expansion Name (7 Characters Max.) ACC2 Get Expansion Serial Number

Expansion Serial Number (S.N.) 0

Total number of thermocouples to use: no thermocouples

- no thermocouples
- no thermocouples**
- 1 thermocouple
- 2 thermocouples
- 3 thermocouples
- 4 thermocouples

• 4 analog channels 0-5 V/0-12 V

ID	<input checked="" type="checkbox"/>	Name	Function	Sensor	Unit	Freq
Ch01	<input checked="" type="checkbox"/>	ACC2 Channel01	Voltage	Generic 0-5 V	mV	20 Hz
Ch02	<input checked="" type="checkbox"/>	ACC2 Channel02	Voltage	Generic 0-5 V	mV	20 Hz
Ch03	<input checked="" type="checkbox"/>	ACC2 Channel03	Voltage	Generic 0-5 V	mV	20 Hz
Ch04	<input checked="" type="checkbox"/>	ACC2 Channel04	Voltage	Generic 0-5 V	mV	20 Hz

GPS09c Pro and GPS09c Pro Open

Clicking the channels it is possible to set: name, display name and display precision.

Expansion Name (7 Characters Max.) GPS Pro Get Expansion Serial Number

Expansion Serial Number (S.N.) 0

ID	<input checked="" type="checkbox"/>	Name	Function	Sensor	Unit	Freq
Acc1	<input checked="" type="checkbox"/>	GPS Pro InlineAcc	Inline Acceleration	Internal Accelerometer	g 0.01	50 Hz
Acc2	<input checked="" type="checkbox"/>	GPS Pro LateralAcc	Lateral Acceleration	Internal Accelerometer	g 0.01	50 Hz
Acc3	<input checked="" type="checkbox"/>	GPS Pro VerticalAcc	Vertical Acceleration	Internal Accelerometer	g 0.01	50 Hz
Gyr1	<input checked="" type="checkbox"/>	GPS Pro RollRate	Roll Rate	Internal Gyro	deg/s 0.1	50 Hz
Gyr2	<input checked="" type="checkbox"/>	GPS Pro PitchRate	Pitch Rate	Internal Gyro	deg/s 0.1	50 Hz
Gyr3	<input checked="" type="checkbox"/>	GPS Pro YawRate	Yaw Rate	Internal Gyro	deg/s 0.1	50 Hz

4.4 – Math channels configuration

As for any other AiM logger it is possible to add Math channels choosing them in a wide library. This can be done using the channels provided by the vehicle ECU or adding and configuring optional custom sensors.

To create math channels; available options are:

- Bias: considering a relation between two mutually compatible channels it computes which one is prevailing (typically used for suspensions or brakes);
- Bias with threshold: it needs the user to set a threshold value for the considered channels; once these threshold are both exceeded the system makes the calculation;
- Calculated gear: it calculates the gear position using engine RPM and vehicle speed
- Precalculated gear: it calculates the gear position using Load/Shaft ratio for each gear and for the vehicle axle too
- Linear correction: typically used when a channel is not available in the desired format or if it is wrongly tuned and cannot be tuned again
- Simple operation: to add or subtract from a channel value a constant value or another channel value
- Division Integer: to get the integer part of the division
- Division Modulo: to get the remainder part of the division
- Bit composed: to compose 8 flags in a bit-field measure Each option asks the user to fill in a proper panel.

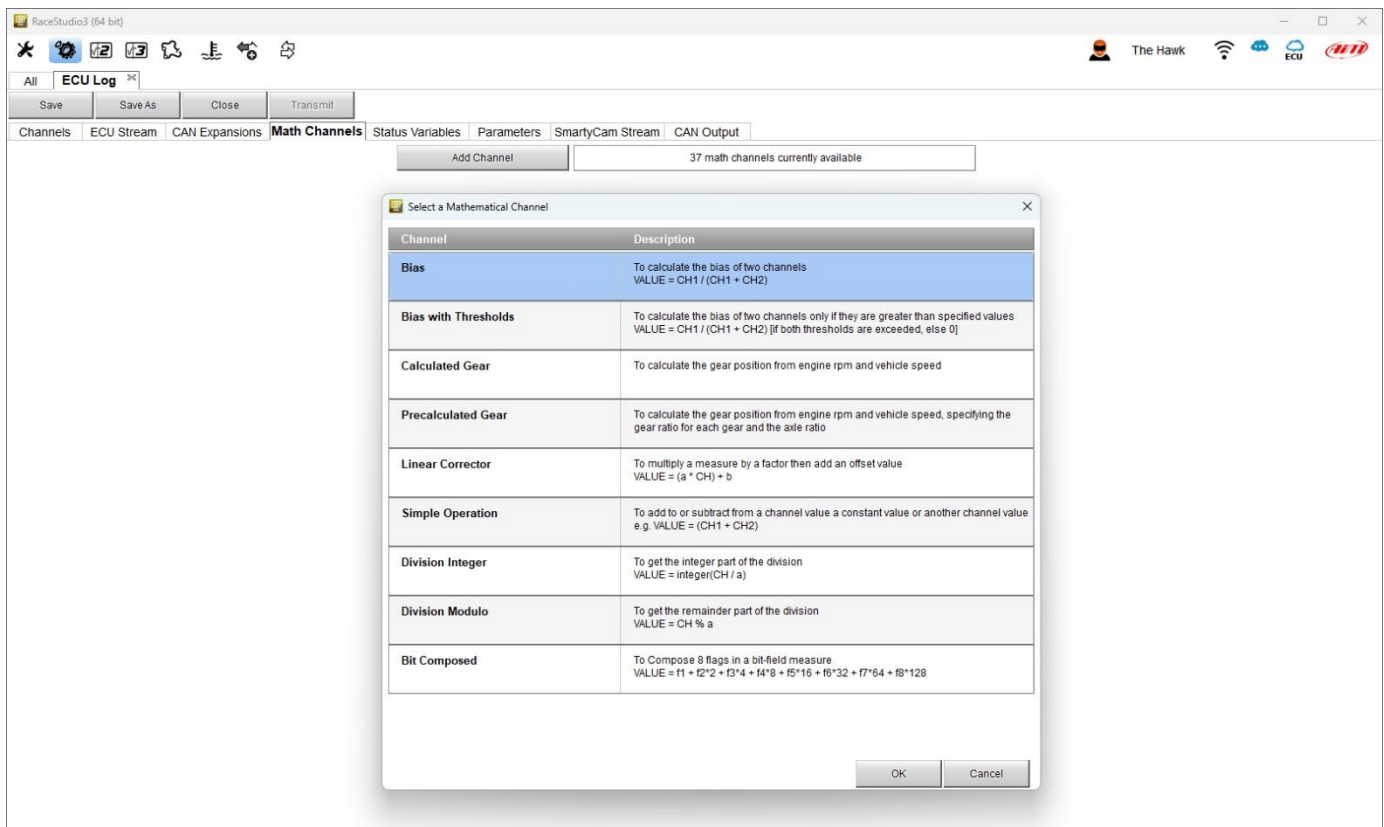

4.5 – Status Variables configuration

As any AiM logger ECULog allows to set different Status Variables. To do so press “Add Status Variable” button and fill in Name and display label. Status variable values can also be recorded enabling the related top left checkbox (highlighted below).

They **can work** as:

- Momentary: when operating condition occurs output sets to “Active” status; as soon as it is released output comes back to its resting “not active” status; labels can be edited
- Toggle: when operating condition occurs output sets to “Active” status even after releasing the button; when pressed again output comes back to its resting “not active” status; labels can be edited
- or Multiposition: see following pages.

Status variables can be **activated/deactivated** using:

- the same conditions for both actions
- distinct conditions for activation and deactivation
- multiple output values each with its own condition

The **condition can be**:

- always True
- always False
- custom

The screenshot shows the 'Status Variable Settings' dialog in RaceStudio3. Key elements include:

- Name:** A text input field.
- Display Label:** A text input field with 'Stat' entered.
- Record values:** A checked checkbox.
- Sampling Frequency:** A dropdown menu set to '10 Hz'.
- Same condition for activation and deactivation:** A dropdown menu with options: 'Same condition for activation and deactivation', 'Distinct conditions for activation and deactivation', and 'Multiple output values each with its own condition'.
- Work As:** Radio buttons for 'Momentary', 'Toggle', and 'Multiposition'. 'Momentary' is selected.
- Use timing:** A checked checkbox with a 'Time threshold between short and long status' field set to '0.5 sec'.
- Status Labels and Values:**

Rest Status	Short Status	Long Status
Label	Label	Label
S0	S1	S2
0	1	2
- Activated/Deactivated:** Fields for 'Activated when following condition is verified for at least 0 sec' and 'Deactivated when following condition is not verified for at least 0 sec'.
- Condition Dialog:** A sub-dialog showing 'Always FALSE', 'Always TRUE', and 'Always FALSE' radio buttons. The 'R8 RPM' radio button is selected with a condition of 'greater than 1000 rpm'.



As shown here below **Momentary** and **toggle** working mode only allows to generate a square wave whose duration of each status can be customized.

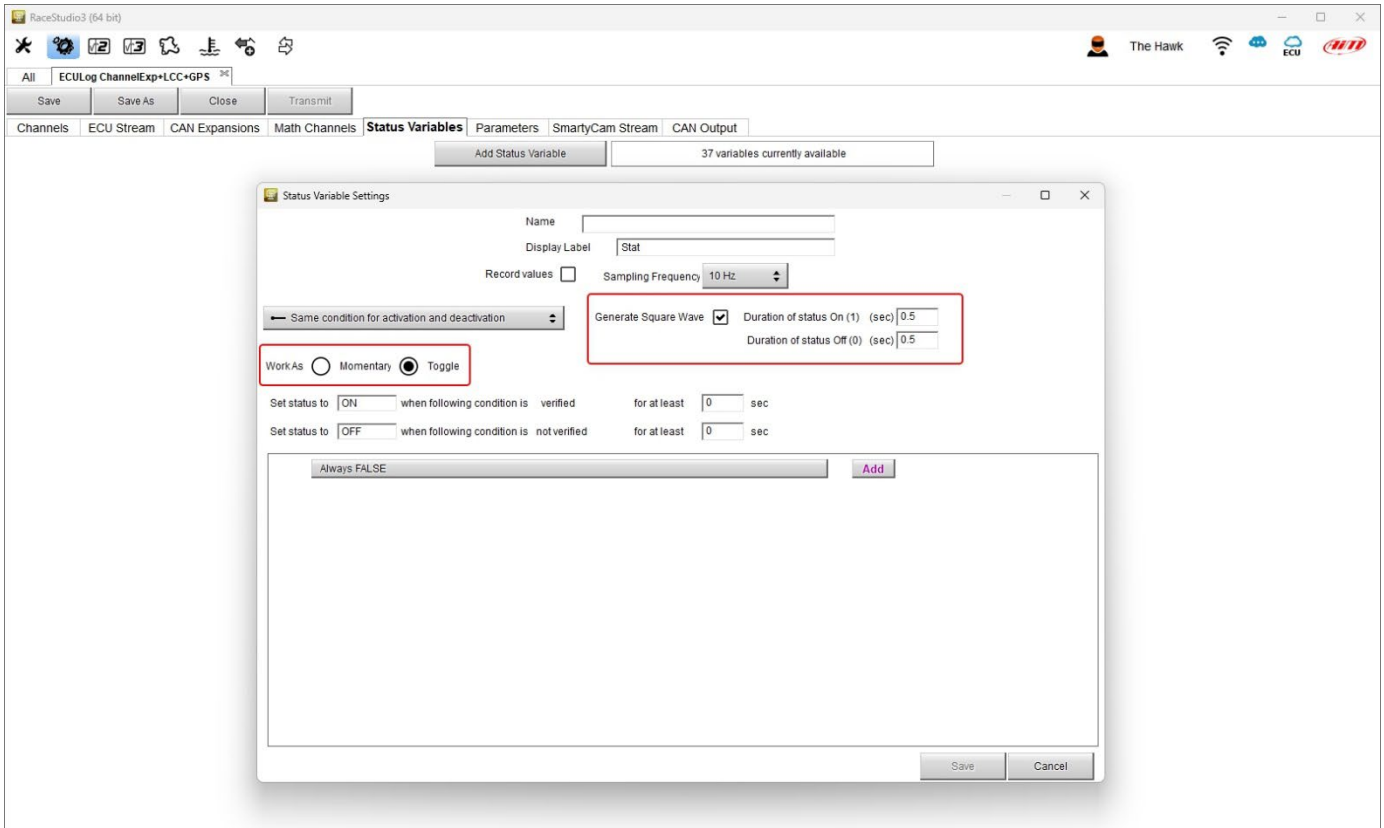



When the status variable is set as Multiposition the different positions as well the time threshold (if desired) need to be set. On the contrary activation/deactivation conditions, possibility to record values and condition type are the same of Momentary and Toggle working mode.

The screenshot shows the 'Status Variable Settings' dialog box within the RaceStudio3 application. The dialog is titled 'Status Variable Settings' and has a close button (X) in the top right corner. It contains several fields and options for configuring a status variable.

Fields and options include:

- Name: [Empty text box]
- Display Label: Stat
- Record values:
- Sampling Frequency: 10 Hz
- Generate Square Wave:
- Duration of status On (1) (sec): 0.5
- Duration of status Off (0) (sec): 0.5
- Work As: Momentary, Toggle, Multiposition
- Use timing: Time threshold between short and long status sec: 0.5
- Table with columns: Position, Label, Value, Short Time leads to, Long Time leads to, and a plus sign button.
- Activated: when following condition is verified for at least 0 sec
- Deactivated: when following condition is not verified for at least 0 sec
- Always FALSE button and Add button
- Save and Cancel buttons at the bottom right.

A yellow callout box points to the 'Multiposition' radio button with the following text: "Each time operating conditions occurs, output sets to next status even after releasing button. After last status, its repeats the cycle starting from the first one. You can edit all the status labels."

Position	Label	Value	Short Time leads to	Long Time leads to	
0	S0	0	S1	S1	+
1	S1	1	S0	S0	+

4.6 – Parameters configuration

Parameters Tab allows to set:

Lap Detection (1): you can set the seconds the lap time is hold on the display; available options are:

- from GPS: track width needs to be filled in
- from optical beacon: it is possible to set a time period during which additional lap signals are ignored to avoid double lap time recording.

Reference Speed (2):

- default setting is “GPS Speed” but if an additional speed source is available it is possible to change it pressing the related button.

Start data recording conditions (3):

- default condition is RPM greater than 850 or speed is greater than 6 mph but pressing “Add” button it is possible to customize the conditions through the panel that is prompted.

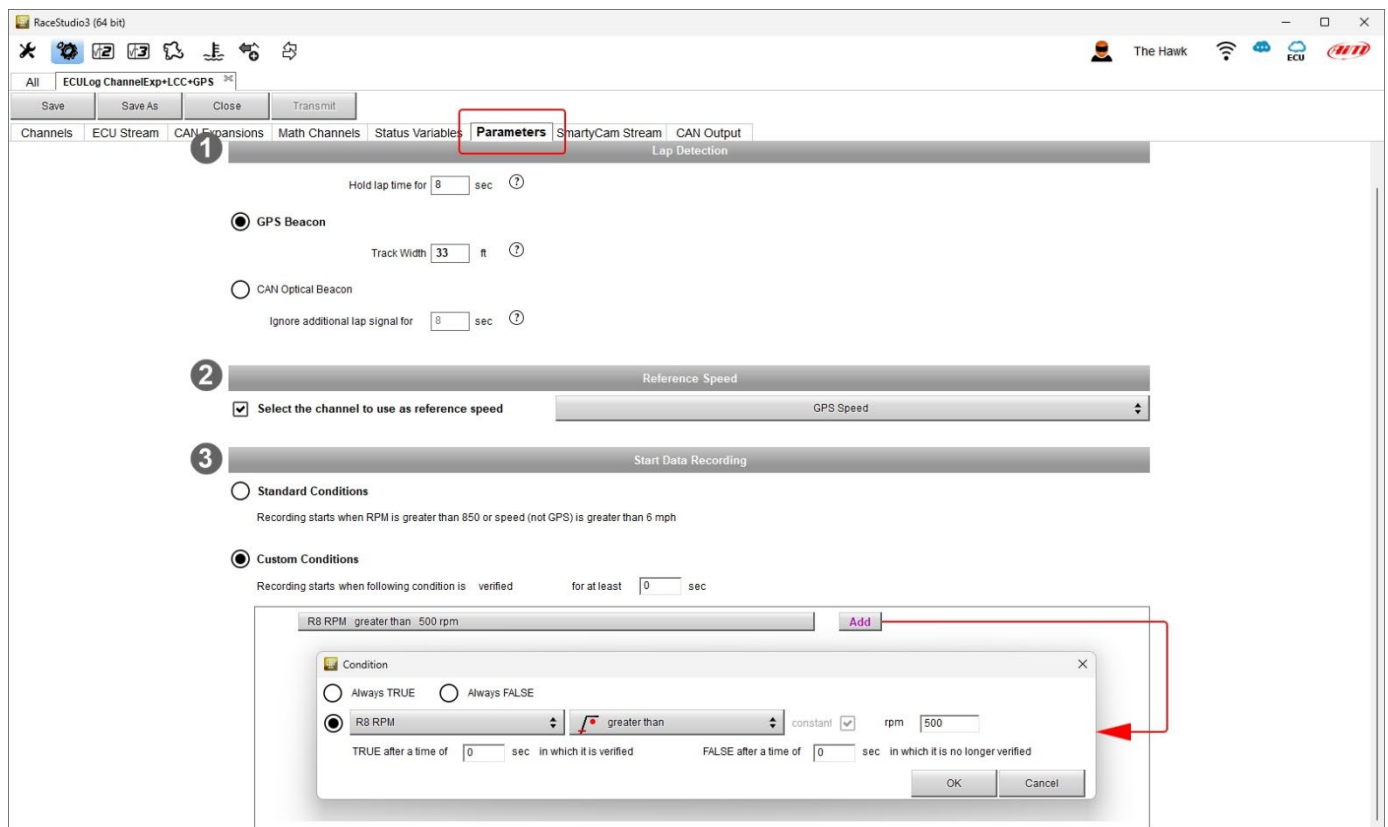

4.7 – SmartyCam Stream

ECULog can be connected to both AiM SmartyCam 2 and SmartyCam 3 through the CAN Bus to show the desired data on SmartyCam video. The logger transmits data to the Cameras in two slightly different ways according to the camera and to the fixed setting. Available options are:

- SmartyCam 2 and SmartyCam 3 Default
- SmartyCam 3 Advanced

For ECULog to transmit each channel when connected to SmartyCam 2 or SmartyCam 3 default:

- enter “SmartyCam stream” tab
- it shows all channels and/or sensors that fits the selected function
- in case the desired channel or sensor is not in the list enable “Enable all channels for functions” checkbox and all channels/sensors will be shown

AiM default protocol transmits a rather limited range of information, enough for a wide range of installation.

ID	SmartyCam Function	Channel
CC01	Engine RPM	R8 RPM
CC02	Speed	GPS Speed
CC03	Gear	R8 GEAR
CC04	Water Temp	R8 WATER TEMP
CC05	Head Temp	--- No available channel ---
CC06	Exhaust Temp	--- No available channel ---
CC07	Oil Temp	R8 OIL TEMP
CC08	Oil Press	--- No available channel ---
CC09	Brake Press	R8 BRK PRESS
CC10	Throttle Pos	R8 TPS
CC11	Brake Pos	--- No available channel ---
CC12	Clutch Pos	--- No available channel ---
CC13	Steering Pos	--- No available channel ---
CC14	Lambda	Lambda
CC15	Lateral Accel	GPS Pro LateralAcc
CC16	Inline Accel	GPS Pro InlineAcc
CC17	Fuel Level	--- No available channel ---
CC18	Battery Voltage	--- No available channel ---
CC19	Vertical Accel	GPS Pro VerticalAcc

To transmit a different set of information a **SmartyCam 3 with advanced setting** is needed; **please note: this function is for expert users only**. Please follow this procedure:

- configure ECULog in order to transmit a different SmartyCam stream
- select the SmartyCam stream in SmartyCam 3 configuration
- select “SmartyCam 3 -> Advanced” option in SmartyCam Stream tab
- press “Add new Payload”
- create your desired stream defining the required IDs fields and save it pressing “OK”
- name the protocol

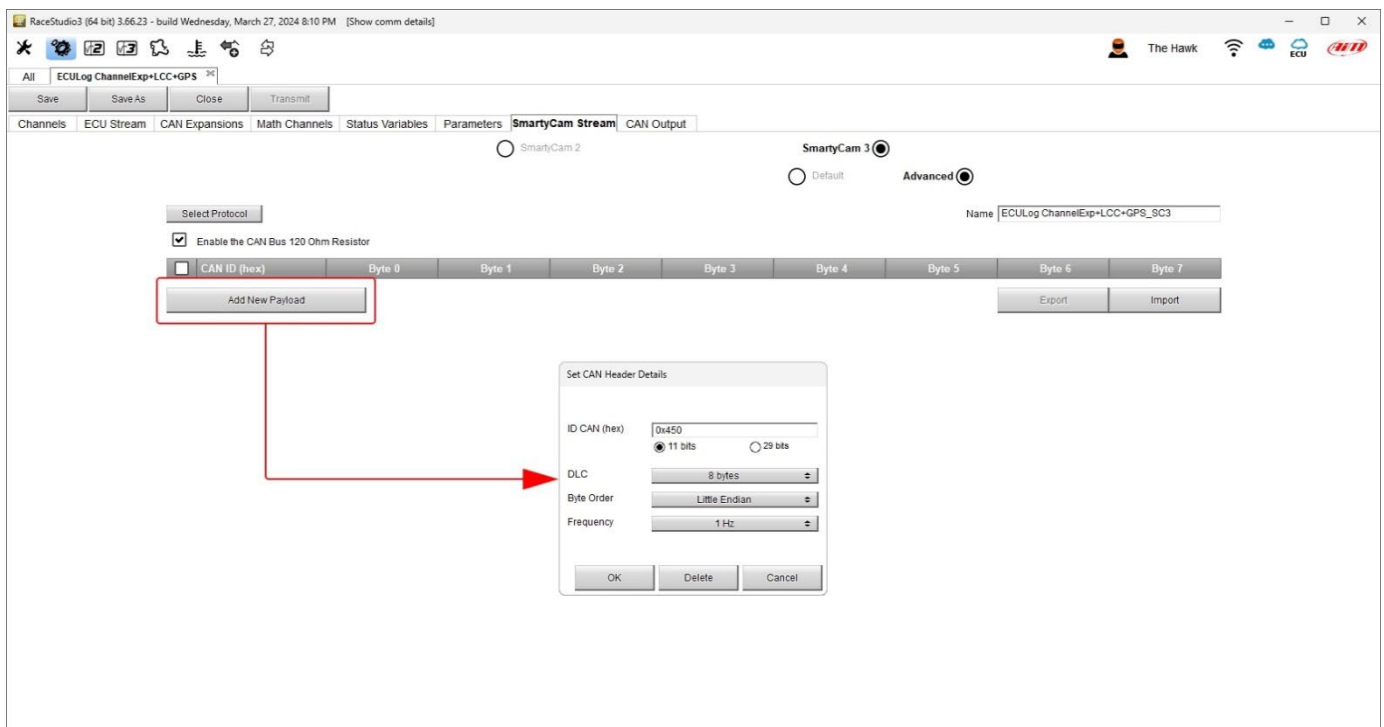

4.8 – CAN Output configuration

The logger can transmit a CAN data stream containing the channels required on AiM CAN bus. It works exactly as SmartyCam 3 advanced stream.

4.9 – Transmitting the configuration to ECULog

Once all the tabs set ECULog configuration needs to be saved pressing the related button on the keyboard top left of the configuration Tab. When the configuration has been saved transmit it to ECULog pressing “Transmit” button on the same keyboard. ECULog needs to be connected to the PC through the USB A – USB C cable.

Once the configuration saved press “Transmit” button on the same keyboard.

5 – Dimensions, pinout and technical characteristics

The image below shows ECULog dimensions in mm [inches].

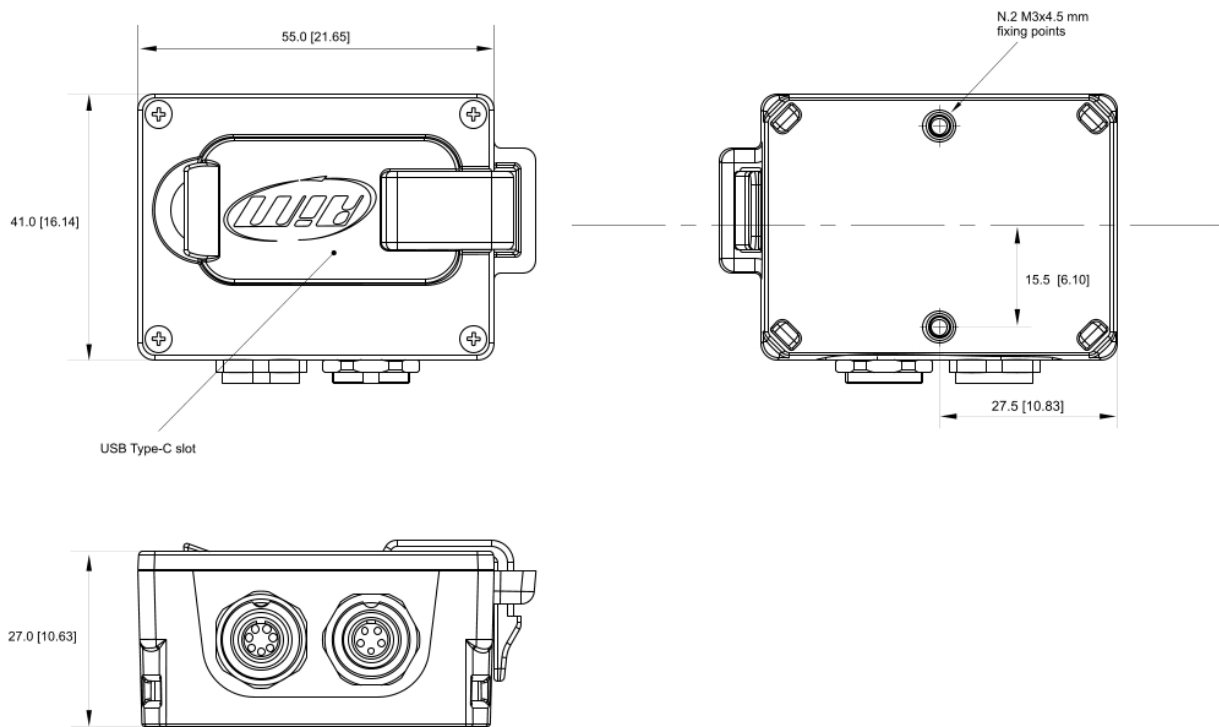

The image below shows ECULog pinout.

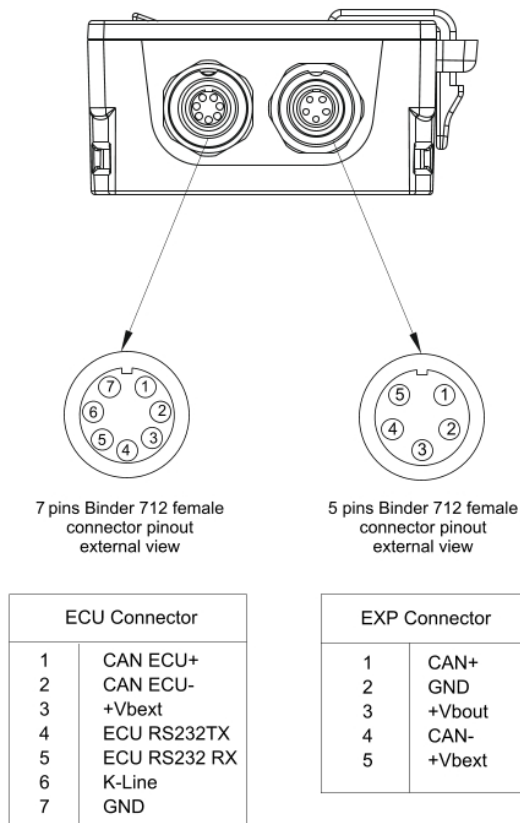

Technical characteristics:

- ECU connection: CAN, RS232 or K-Line to 1.000+ industry leading ECUs
- Expansions: Channel Expansion, ACC, ACC2, LCU-One CAN, LCU1, SmartyCam 3 Series, GPS09c/GPS09c Pro Module
- External Power: 9-15 C
- Connectors: 1 socket 5 pins Binder 712 connector
1 socket 7 pins Binder 712 connector
1 USB Type-C
- Memory: 4 GB + 16 GB removable USB-C memory card
- Material: PA6 GS30%
- Dimensions: 61.4x44.7x24.2 mm
- Weight: 100 g approximately
- Waterproof: IP65

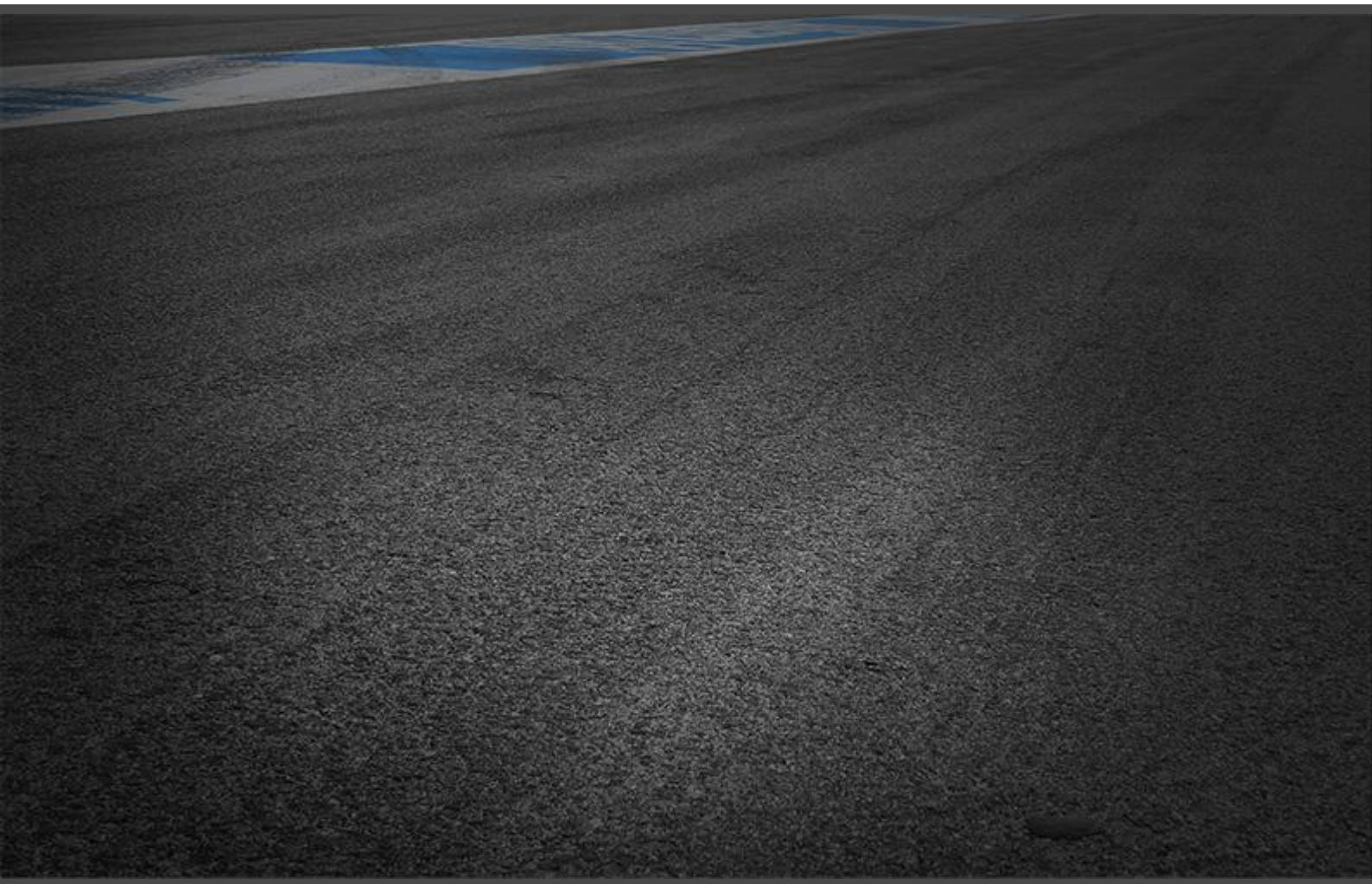

memotec GmbH
Bauwaldstrasse 1
D-75031 Eppingen

+49.7260.920440
info@me-mo-tec.de

www.me-mo-tec.de